





## LED POLE LIGHT



**PRODUCT DESCRIPTION**

This light's cutting edge optical design provides superior illumination and precision glare control. The unique cooling channel design promotes efficient heat dissipation and ensures a longer lifespan whether you have a new construction or upgrade application.

**Applications:** Parking lots, roadways, walkways, and general sites

**ACCESSORIES**

Arm Mount Bracket



Slip Fitter Bracket



Trunnion Bracket



## DIMENSIONS

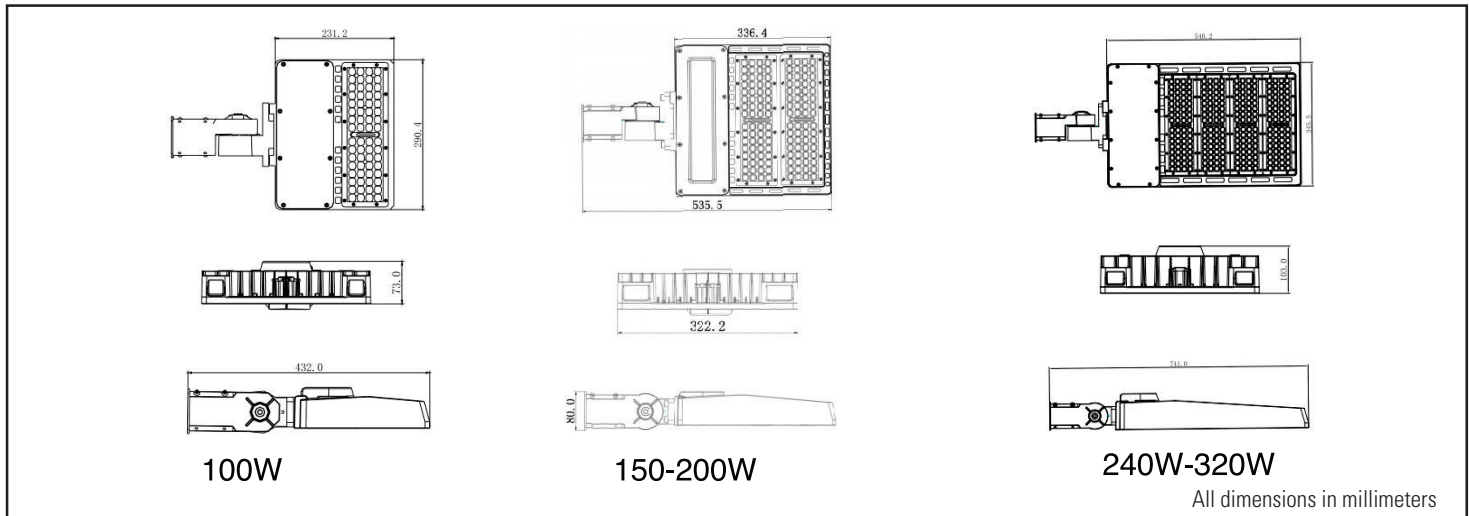

## SPECIFICATIONS

Part Number	Input Power	Input Voltage	Efficiency	CCT	Light Distribution	CRI	Certificates	Warranty
JH-SBS100W-82F	100W	100-277VAC	120Lm/W	3000-5700K	TYPE II/III/IV/V	75	UL, RoHS	5 Years
JH-SBS150W-82F	150W	100-277VAC	120Lm/W	3000-5700K	TYPE II/III/IV/V	75	UL, RoHS	5 Years
JH-SBS200W-82F	200W	100-277VAC	120Lm/W	3000-5700K	TYPE II/III/IV/V	75	UL, RoHS	5 Years
JH-SBS240W-82F	240W	100-277VAC	120Lm/W	3000-5700K	TYPE II/III/IV/V	75	UL, RoHS	5 Years
JH-SBS320W-82F	320W	100-277VAC	120Lm/W	3000-5700K	TYPE II/III/IV/V	75	UL, RoHS	5 Years